

OUTSIDE HOME

weinor patio roofs and Glasoasen®







Frame colour WT 029/80077 | Pattern 3-641 apple



www.weinor.com/terrazzaoriginale



Frame colour WT 029/80077

Terrazza Originale patio roof

Enjoy life al fresco

Enjoy your patio until well into autumn – weinor's Terrazza Originale patio roof will keep you well sheltered from the wind and other elements. And your patio furniture can remain outside without being damaged. The appeal of weinor's patio roof is its elegant construction, attractively shaped design and high durability. With numerous versions available, it is also very suited to many different types of houses and requirements.





Frame colour RAL 9016

The **very best patio roof** for any application – and completely bespoke

Every weinor patio roof/veranda is of the highest quality. The stable aluminium construction is powder coated using a state of the art process and there are over 200 frame colours available to choose from. Alongside the use of the very highest quality stainless steel screws there is maximum resistance to corrosion. The result is a roof that can be enjoyed for many years trouble free. The special gutter construction allows unobstructed views of the outside as widths of up to 7 metres can be achieved without the need for additional posts in the middle.

Terrazza Originale – Highlights and versions



Elegant design – as if from one casting

The weinor Terrazza Originale patio roof captivates through its harmonious design. The elegant yet rigid construction is thought out down to the finest detail:

- almost all fixings are concealed for a clean appearance
- corrosion-resistant with powder coated aluminium profiles and stainless steel screws



Rigid roof covering – resilient and shatter-proof

The weinor Terrazza is designed for use with high quality for high-quality laminated safety glass (LSG):

- glazing can be 10 or 12 mm LSG
- if required, the roof can carry a snow load from 75 N/m² up to 550 N/m²

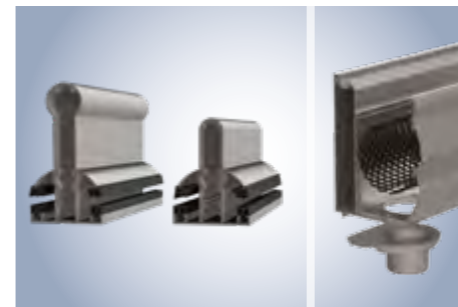

Rigid aluminium construction

The Terrazza Originale stands out for its exceptional stability and durability. All patio roofs meet the standards and specifications and are designed to withstand wind and snow burdens according to static calculations.

- sturdy roof supports in a variety of configurations
- extra-thick walls in a slim structure
- steel inserts optionally available, also as guttering reinforcements if required
- roof depths up to 6 m

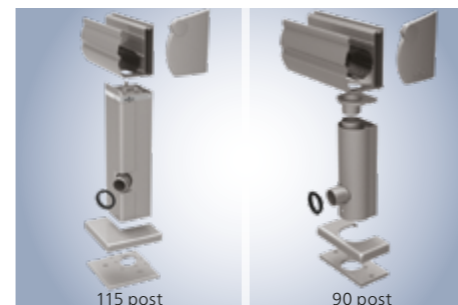

Invisibly integrated drainage

Rainwater is efficiently drained away by the discretely integrated gutters and drainage outlets inside the post. The drainage outlet can also be positioned at the end of the gutter profile. The optional foliage screen prevents the ingress of leaves

and the like into the rain gutter. There is a choice of two post styles – 115 post (square) and 90 post (round). So the best match can be made to either the existing surroundings or simply a preferred style.

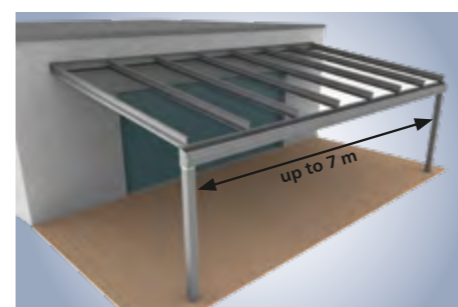

220 guttering – large spans without middle posts

Anyone spending time under a patio roof wants to enjoy an unobstructed view. With the 220 guttering combined with

the 115 post, larger spans are also feasible without middle posts, so nothing obstructs the view.



Terrazza Originale/Plus – Roof types and accessories

Two roof models – equipped exactly the way you need them

To ensure that the roof is a perfect match for the facade it is fitting to, there are several different options and roof types to choose from (see p. 11).



Patio roof without overhang, with integrated guttering

The basic model comes in a classic lean to design: if you don't need an additional roof overhang, you will find the **Terrazza Originale** a good solution.



Patio roof with roof overhang and integrated guttering

Or opt for a **Terrazza Originale Plus** with roof overhang and integrated downspout – to make sure the rain drains off as it should.

Attractive post forms – square or round

The posts of the Terrazza Originale/Plus are available in square or round design. So there is the right patio roof for every building type, no matter if classic or modern. You can choose between 200 RAL frame colours to match any current trend or existing colour scheme.



Patio roof with post 115 (square)



Patio roof with post 90 (round)



Frame colour WT 029/71289

Terrazza Originale/Plus – Styles of roof

Roof models



Terrazza Originale model without roof overhang and with integrated guttering

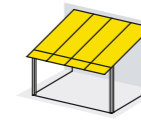

Terrazza Originale Plus model with roof overhang and integrated guttering

Roof types for Terrazza Originale patio roof and Glasoase®



Pent roof – Type A



Sloping pent roof – Type B

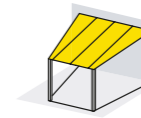

Trapezium-shaped roof sloping to eaves – Type C

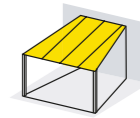

Trapezium-shaped roof sloping to ridge – Type C



Pent roof with wall offset



Pent roof with roof guttering offset

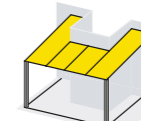

Pent roof with balcony cutout



Hipped pent roof



Pent roof, hipped and sloping forwards

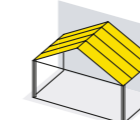

Gable roof – Type L



Circumferential pent roof – Type N

Contact your weinor retailer for advice!

weinor patio roofs and Glasoasen® blend in to the shape and appearance of any building facade – even on protruding walls and corner solutions. Your weinor retailer will be happy to explain to you which style of roof is suitable for your needs. Most roof models and types can be very easily combined with weinor glazed elements.

Matching side glazing – tailored to your needs and wishes

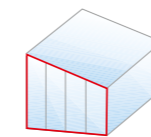

Maximum transparency: SUPER LITE side element w50-c
Adding fixed glazing below the side roof support opens up the possibility to include fully-transparent front panels – with not a single vertical or horizontal strut in sight.

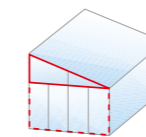

Complements the full glass sliding door: LITE side element
Lightweight fixed glazing at the top of the trapezium, with a weinor full glass sliding wall below – if you go this way, you'll be choosing a very popular combination!

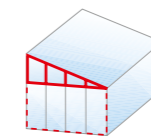

As stable as they come: CLASSIC side element
Or go for sturdy fixed glazing at the top of the trapezium, with a full glass sliding door below – or even framed fixed glazing to hold off strong side winds if you prefer.



Frame colour WT 029/80077



www.weinor.com/glasoase



Frame colour WT 029/90147

weinor Glasoase® Light-flooded elegance

Bring your garden into your house – with the elegant weinor Glasoase® that offers you smooth transitions to the outside. This glass oasis is a combination of a Terrazza Originale patio roof comprising all-glass elements that can be closed to form an uninsulated conservatory. The many flexible and fixed-glazed side elements allow for any number of possible combinations. To see our roof shapes, please go to p. 11.

Awarded with:



reddot design award
winner 2009
weinor Glasoase®



Frame colour WT 029/80077



www.weinor.com/w17easy

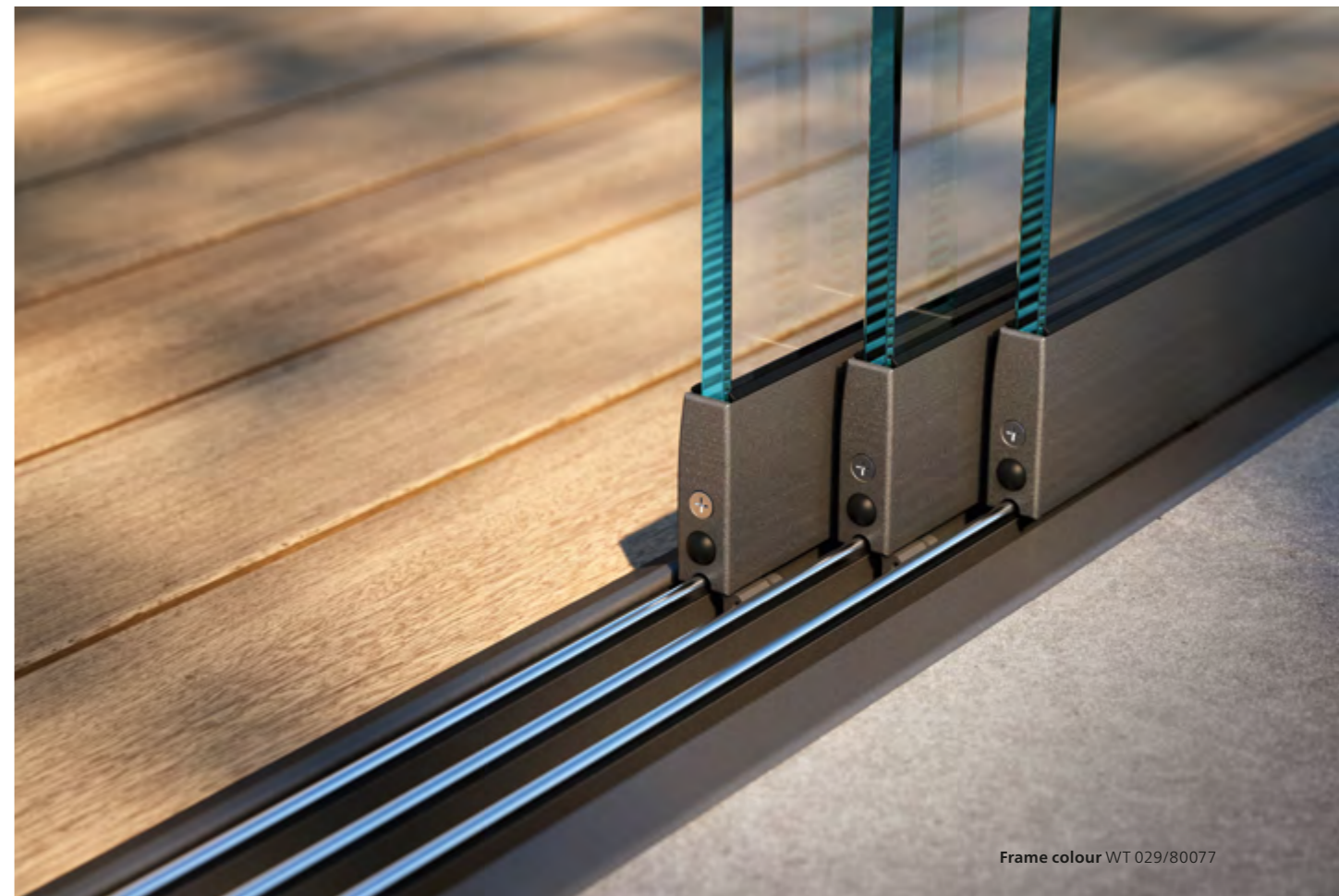

Frame colour WT 029/80077

W17 EASY

The effortless full glass sliding door

Whether you want it protected and cozy or fresh and airy: With the frameless glass sliding door w17 easy you will always experience pure living pleasure – on your patio. It could not be simpler – thanks to premium fitting technology, the glass sliding door from weinor can be easily operated and locked if required.

Awarded with:



reddot award 2017
winner



Full glass sliding door w17 easy

Highlights, features and benefits

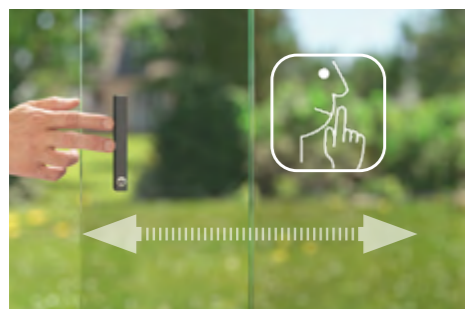

Soft-Sliding-System

The w17 easy full glass sliding door is supplied as standard with the Soft-Sliding-System. It allows for the extremely quiet and easy movement of the glass leaves. The system also comes with high-quality stainless steel

rollers and guide rails. In addition, all the leaf actuators, leaf stop bars are fitted with softer cushioning elements at the end positions and on the wall gap sealing profiles.



Lockplate version – opens on two sides, closes in the centre



Single system – opens on one or two sides, closes on the left and/or right

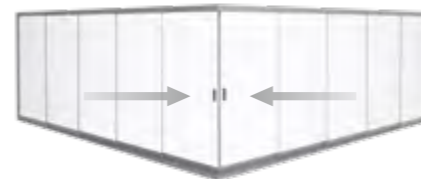

Corner unit – frameless full glass corner, e.g. for balconies and loggias

Technical data

w17 easy full glass sliding door

	Single system	Lockplate version
Max. width of system	6.6 m	10 m
Max. height of system*	2.8 m	2.8 m
Number of leaves	2 to 5	4 to 10
Guide rail type	2-track to 5-track	2-track to 5-track
Opening type	Parallel-sliding	Parallel-sliding
Type of glass (single-pane safety glass)	6, 8 or 10 mm	6, 8 or 10 mm
Height compensation in the upper rail	Standard: 0 mm/-25 mm	Standard: 0 mm/-25 mm
Wall gap sealing profile	Option	Option
Brushes and gap seals	Option	Option
Soft-Sliding-System	Standard	Standard
Corner unit	90°	90°

* As of a system height of 2.4 m, version w17 easy XXL can be supplied with additional requirements and limitations



Flatter floor rails – elegant and reduced stumbling hazards

Besides the higher standard floor rails with weinor CleanCase® you can also choose the flat version. This version does not have a CleanCase®. The benefit for you: it is so low that it

almost presents no obstacle in transitions – simply accessible! Elegant floor connection profiles that go well with any flooring ensure a nice transition between the floor rail and the patio floor.



Clever CleanCase® – easy cleaning of running rails

The standard floor rail has a practical CleanCase® – for the easy removal of dirt using a hand brush or cloth.

- reliable drainage outside
- also available without CleanCase® with a continuous rail profile



Comfortable foot-operated catch

weinor developed an intelligent fixing mechanism so that the glass leaves remain reliably in the position you want when fully or partly open.

- comfortable to operate without having to bend down
- locking and releasing of w17 easy by applying slight pressure with the foot



High-quality handle and lock versions

The full glass sliding doors can be operated conveniently using the high-quality handle versions.

- standard handles: in stainless steel and the system colour
- cup pull handles in V4A stainless steel

- lockcase and hung bolt: in system colour (A4 stainless steel rust-free lockcase inside, highly corrosion-resistant nickel silver key and profile cylinder), can be locked from the inside, can be locked from both sides as an option



Retrofittable – for virtually every patio roof or veranda

Being a floor-mounted structure, weinor's full glass sliding door wall fits under virtually every patio roof as well as many other roof structures.

- weinor's patio roof can be extended to create a Glasoase®

- no additional costs for structural safety adjustments
- matching profiles from weinor for easy retrofitting
- easy to clean and easily accessible from the outside



Frame colour WT 029/70786 | Pattern 4-669 greige moon



Frame colour WT 029/80081 | Pattern StarScreen 7-103 sand

Sottezza Pure or Originale, WGM Top and VertiTex II The perfect sun shades

With the right form of sun protection for your patio roof, Glasoase® or conservatory, the fabric will provide you with textile protection against the heat, glare and prying eyes – and also make you feel even more at home. For well-ventilated patio roofs and Glasoasen®, an undermounted conservatory awning often suffices for glare protection. A conservatory can quickly become very warm when the sun shines in directly. This is where a roof-mounted conservatory awning can help to provide a pleasant room climate. The vertical sun protection VertiTex II provides protection against the sun and prying eyes.



Frame colour WT 029/90146 | Pattern 3-8473-847 porcelain

www.weinor.com/wgmpop

Heat and glare protection that stand the test of time

The over roof shading system WGM Top ensures the space underneath your conservatory or glass room does not heat up too much. It stops the sun hitting the glass roof so heat build up is not an issue. The all-round enclosed and robust awning cassette keeps the fabric and other component parts well protected from the elements. You can enjoy superb weather protection for many years.

WGM Top – Highlights and benefits



Pleasant climate in the conservatory or under the glass patio roof

The WGM Top can be retrofitted to a whole range of different untrussed roofs. It protects against overheating, thus contributing to a pleasant atmosphere.

- suitable for larger cross sections and dimensions up to 36 m²

- wind-resistant up to wind force 6 on the Beaufort scale
- elegant design without any screws, caps or fixings
- also with overhang for more shaded patio area



Functioning principle of OptiStretch

Clever Stretch and OptiStretch versions

WGM Top Stretch: the consistent tension and fabric position creates a cosy atmosphere.

- **Stretch:** held captive on 2 sides, easy to install, cost effective solution

WGM Top OptiStretch: superb tension with reduced sagging and no light gaps. Improved performance during operation.

- **OptiStretch:** held captive on all 4 sides, no light gaps



Supporting brackets for every requirement

The conservatory awning WGM Top support brackets convince with their high stability and impress with their subtle and almost screwless look. The

awning height can be individually adjusted thanks to the different versions (fixed, adjustable, standard and special version).



Quiet and consistent operation

The WGM Top tension system ensures optimum fabric performance and positioning. It includes, amongst other things, a new flat rope and the tried and tested weinor carriage system.

The flat rope is extremely quiet and durable, the weinor carriage system features quiet retraction and extension that is gentle on materials.



Sun, wind and rain sensors

Radio sensors provide maximum convenience. They open the awning automatically when the sun comes out and retract it in the rain and wind.

Available in the following versions:

- sun/wind/rain sensor
- sun/wind sensor
- sun sensor
- wind sensor

WGM Top Stretch/OptiStretch

Max. width 6.5 m with 5 m projection

Max. projection 6 m with 6 m width



Frame colour WT 029/70786 | Pattern 4-669 greige moon

www.weinor.com/sottezza

Undermounted sun protection with a homely flair

As attractive glare protection, the undermounted conservatory awnings from the Sottezza family are always suitable when sufficient air circulation is provided for under the Glasoasen® or patio roof. The customisable sizes also make it a good fit for any other rectangular patio roof.

Awarded with:



Sottezza Pure / LED | Sottezza Originale / LED Highlights and versions



Underglass sun protection for cosy living

With their slim shape and an attractive fabric, Sottezza awnings under glass provide homeliness beneath the patio roof. A huge range of fabrics and colours makes designing them a pleasure.

Optically matching for any patio roof

- Suitable for retrofitting almost everywhere
- Also provides shading for large surfaces with multi-section units

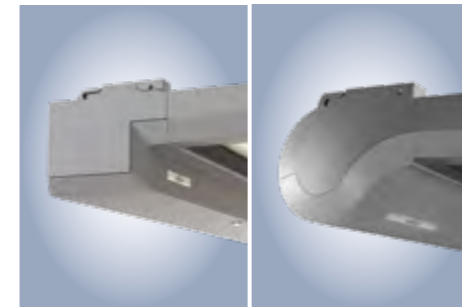

Sottezza Pure and Originale – matching your patio roof

The cubic Sottezza Pure awning under glass complements the linear patio roofs Terrazza Pure and Sempra perfectly, the round Sottezza Originale excellently matches the Terrazza Originale.

- Cubic or round for all lifestyles
- The ideal design for all weinor patio roofs
- Also for patio roofs from other manufacturers



Long evenings with integrated LED lighting

Enjoy long evenings on your patio – harmonious lighting is provided by the Sottezza LED version. The cassette with integrated LED lighting discreetly blends in beneath the patio roof.

- Pleasant warm-white light
- Operating life of 30,000 hours
- Highly energy-efficient
- Dimmable via remote control using a hand transmitter or with a Smart Home app and smartphone or tablet

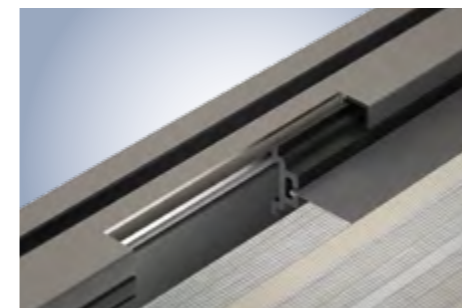

OptiStretch – the best all-around fabric tension

The proven OptiStretch system ensures flawless fabric positioning – and that up to fabric surface areas of 30 m²! It is firmly attached on all sides and needs no light apertures.

- The fabric is positioned securely in the side channel – as a zip would be.
- No side light apertures
- Also available as a cheaper Stretch version with a small light gap



Convincing technology for an evenly taut fabric

The proven rope tensioning system ensures even fabric positioning for Sottezza Pure and Sottezza Originale.

- Tear-resistant and high-tensile rope

- Extremely quiet and easy running
- Tried and tested tension system over many years

	Max. width	Max. projection
Sottezza Pure		
Sottezza Originale		
OptiStretch	6 m	5 m
Stretch	6 m	4 m



Frame colour WT 029/80081 | Pattern 3-716 suede

www.weinor.com/vertitex2



Maximum fabric widths in the smallest cassette

With an exterior vertical shade from our VertiTEx II line, you have an anti-glare screen, wind protection and privacy screen all rolled into one. The patented weinor OptiFlow-System® allows us to use a very small and slim cassette on the VertiTEx II – yet it is still big enough to house large awning fabrics. Regardless of whether it's for the pergola awning, patio roof, Glasoase® or conservatory, the VertiTEx II is always the perfect solution.

Awarded with:



VertiTEx II – Highlights and benefits



Modern design – in two shapes

The VertiTEx II is available with different cassette sizes as well as in a square and round version. Making the vertical awning a true asset for the patio roof.

- desired RAL colour in facade quality
- wide range of fabrics from the screens by weinor® collection – including many seamless fabrics without irritating horizontal seams



* even up to 6 meters width

Ultra-small cassette – even for large system sizes

Exclusively from weinor: Thanks to the weinor Opti-Flow-System® the VertiTEx II has the smallest cassette, even with large widths up to 6 metres.

- cassette sizes: 75 mm, 92 mm and 112 mm
- elegant alternative to exterior blinds, roller shutters etc. (no obstructed views)
- dimensions up to 15 m² possible
- with zip, guide rail or rope



Indented rope

Variant with rope – fits almost any situation and application

The VertiTEx II rope version can have the guide ropes indented if required. This is ideal if there is no fixing at either end, for example indented posts.



VertiTEx WeiTop

VertiTEx WeiTop – simple and precise

VertiTEx WeiTop matches perfectly with the gutter of the terrace roof Terrazza Originale or Glasoase® and is possible up to 6 meters width. With this version the guide rope can also be indented.

- dimensions up to 15 m²
- quick and safe assembly, also retrofittable

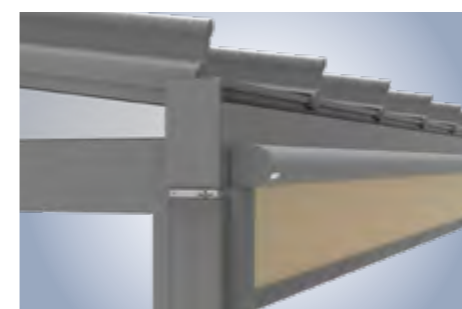

VertiTEx II Zip with 220 guttering

VertiTEx II Zip version – large width and higher wind stability

When combining the weinor Terrazza Originale terrace roof with the vertical awning VertiTEx II Zip, Terrazza Originale is equipped with a higher gutter. This allows larger spans to be achieved without the need of additional middle posts. In

addition, the Zip technology of this version ensures maximum wind stability.

VertiTEx II	max. width	max. height*
Zip	6 m	3 m
Rail	6 m	4 m
Rope	6 m	4 m

* Max. shadeable area: Zip 15 m², rail and rope 14,4 m²

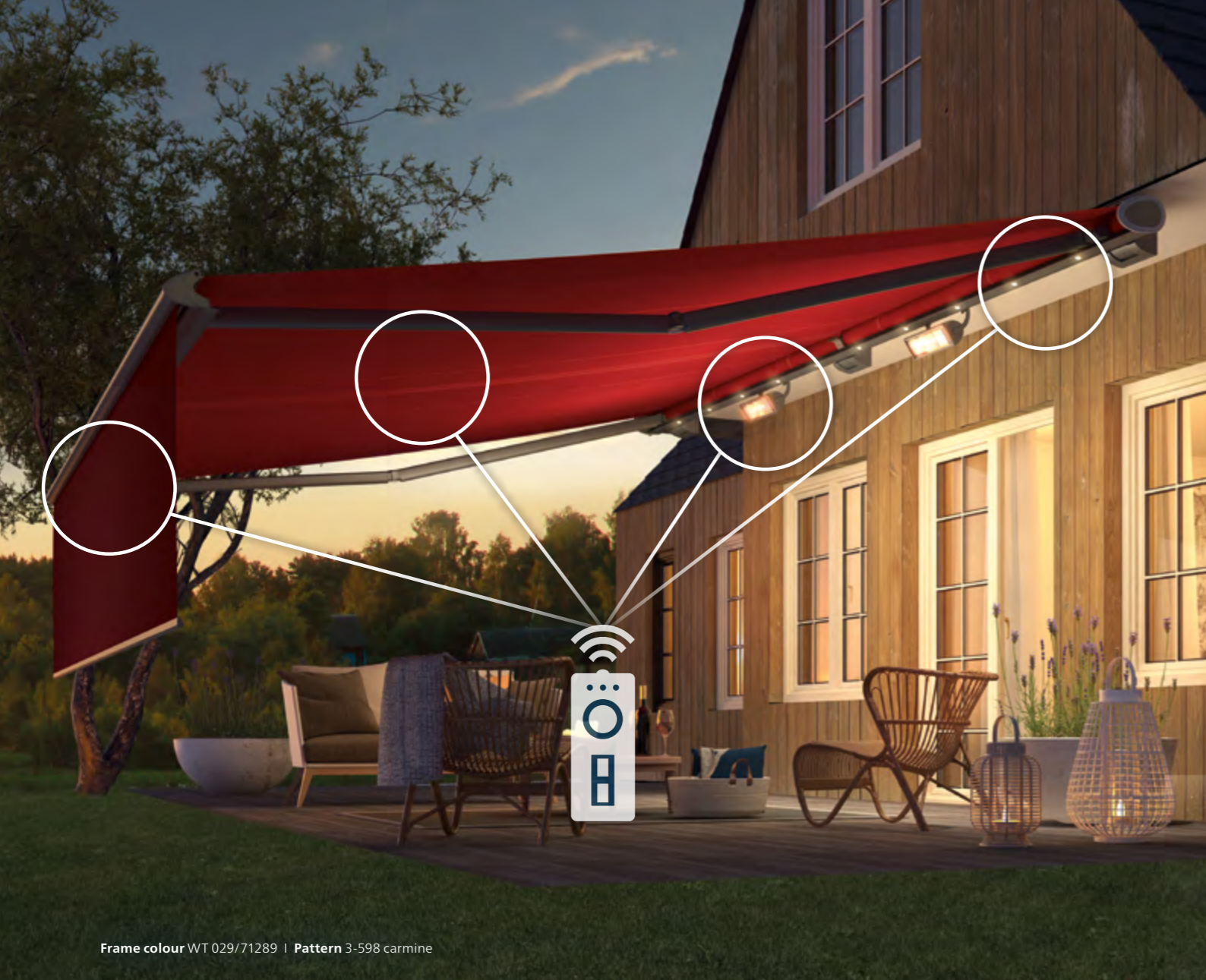

Frame colour WT 029/71289 | Pattern 3-598 carmine

The right control unit to suit all needs

Whether hard wired, remote control or Smart Home, using a hand transmitter, smartphone or automatic weather control – control your awning and accessories really effortlessly with weinor BiConnect or Somfy control units. A gear drive is also possible. The LED lighting and heating can be dimmed fine-tuned via remote control or Smart Home. Your weinor retailer will be happy to advise you competently.

Which control unit fits your needs?



Manual – operation via gear handle

You'd like to operate your awning manually and under your own steam? With a gear handle, it is independent of a power source and can be attached very flexibly at almost all installation locations.

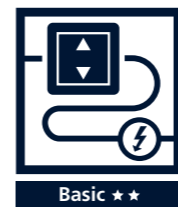

Basic – operation with a hard wired switch or automatic weather system

You would like to operate your weinor awning comfortably via a hard wired wall switch? Your motorised awning can be effortlessly extended and retracted with a simple switch. Optionally, an automatically controlled unit can be used with a sun, wind and rain sensor instead of a hard wired switch.



Convenience – operation with a remote controller plus dimming heating and lighting

You would like to control your weinor awning comfortably via remote control from the patio or the house? That's pretty easy with a remote controller. Optionally, the lighting and the radiant heater can be activated with it and even be dimmed. You can also operate vertical sun protection or further awnings on the house centrally by this means.



Smart – operation with a smart phone, language assistant or pre-set

You'd like to connect your weinor awning, lighting, radiant heater, or other accessories to other devices in your home and control them from anywhere by smartphone or tablet? This is child's play with the weinor BiConnect box or Tahoma Switch from Somfy smart home solution! Also if you would like to operate it using a voice assistant or a pre-set automatic scenario.

Please note that the weinor BiConnect and Somfy systems cannot be combined.

More comfort with side awnings



Paravento – side privacy screen at a flick of the wrist

Our extendable side screen provides a further possibility to better enjoy more privacy: Paravento provides wind and

privacy protection and its fabric and colour can be matched to your awning.



weinor BiEasy

weinor Smart-Home BiConnect box & app



Somfy Smoove Pure Shine

Somfy Situo Pure II

Somfy Smart-Home Tahoma Switch & app

47 standard RAL colours

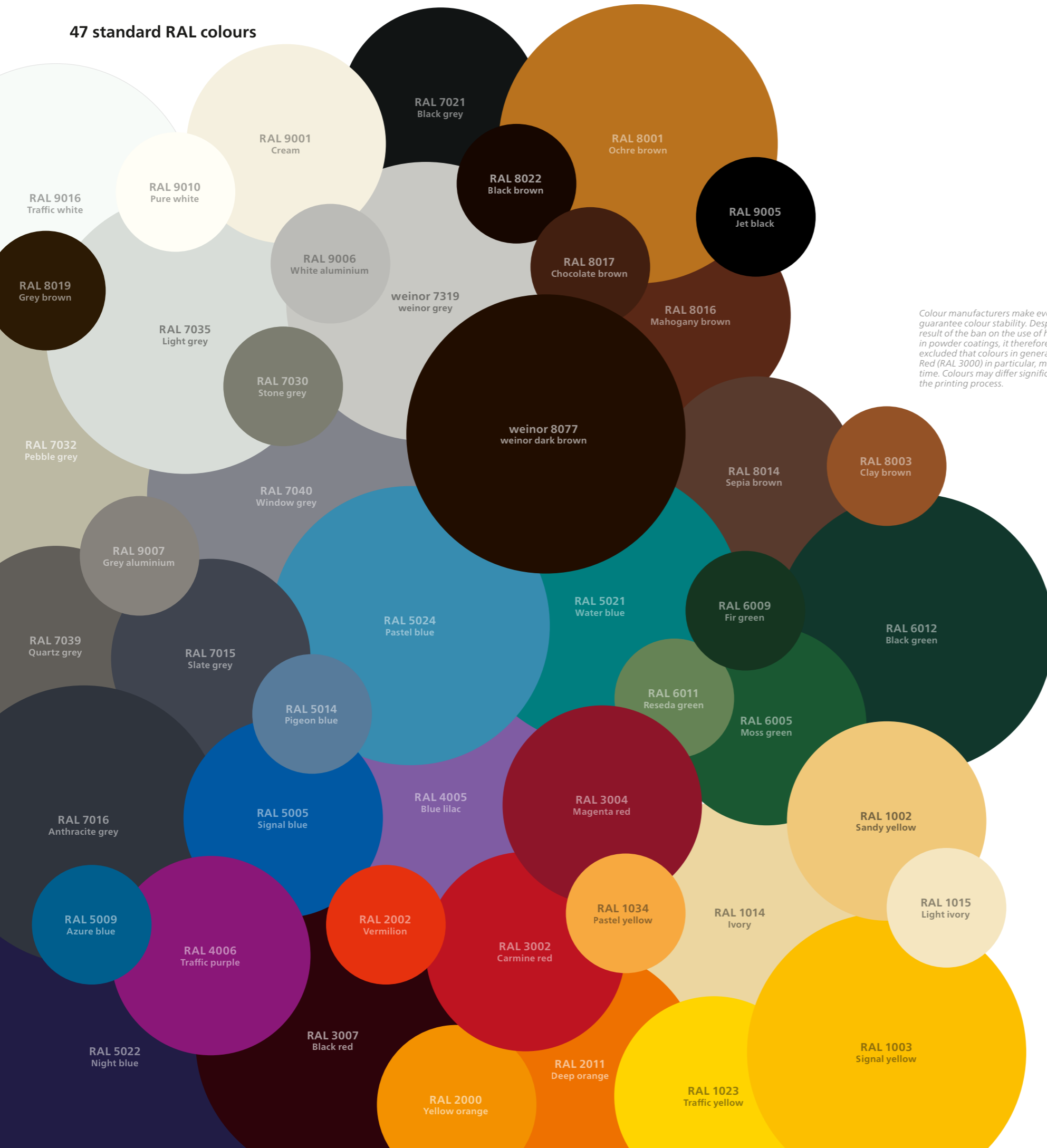

Over 200 modern frame colours

Maximum colour safety: weiner has over 200 different frame colours for you to choose from. You can choose from diverse colours which harmonise with the architecture.

Identical colours – for a perfect match

As weiner does all the powder coating in its own workshop, you can also rest assured that different weiner products come with the same top-class colour tonality and identical gloss level.

Choose from an abundance of high-quality colours:

- 47 standard RAL rack colours, silk gloss
- 9 scratchproof, resistant trend colours with an elegant textured look (standard)
- over 150 special RAL colours

9 trend colours

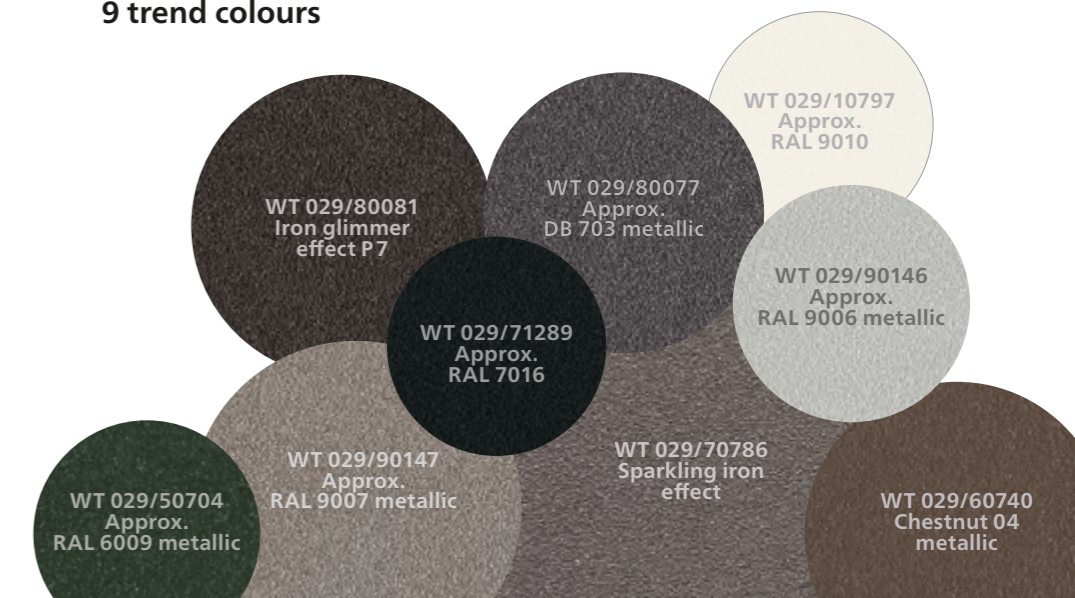



Frame colour WT 029/70786 | Pattern 3-515 alabaster

Award-winning design

Numerous design awards bear testimony to our commitment to provide good designs:



Smaila cassette-awning, 2024
 Artares louvred roof, 2023
 Terrazza Sempra patio roof, 2022
 modern basics blue®
 Sustainable awning fabric collection, 2022
 Kubata cassette-awning, 2019
 Terrazza Pure patio roof, 2019
 VertiTex II vertical-awning, 2019 (Special Mention)
 w17 easy full glass sliding door, 2018
 Opal Design II cassette-awning, 2014 (Special Mention)



modern basics blue®
 Sustainable awning fabric collection, 2021



weinor PergoTex II
 Pergola awning, 2016



Artares louvred roof, 2022
 Terrazza Sempra patio roof, 2021
 modern basics blue®
 Sustainable awning fabric collection, 2021
 Kubata cassette-awning, 2019
 w17 easy full glass sliding door, 2018



Smaila cassette-awning, 2024
 Artares louvred roof, 2022
 modern basics blue®
 Sustainable awning fabric collection, 2021
 Tempura Quadra heating system, 2018
 w17 easy full glass sliding door, 2017
 Semina Life cassette-awning, 2016
 Cassita II cassette-awning, 2014



weinor Glasoase®, 2021



Artares louvred roof, 2022
 Terrazza Pure
 Patio roof, 2019



modern basics blue®
 Sustainable awning fabric collection, 2021



Plaza Viva
 Pergola awning, 2019

weinor products have received more than 40 awards since 2008.
More information at:
www.weinor.com/awards

Top weinor quality for certain



Premium quality
 made in Germany



Most definitely
 an original product

Embodying innovation – constant enhancements

Tried and tested weinor quality – certified production processes, top standards

Sustainability and responsibility – high environmental standards and regular checks

weinor certificate of authenticity

Every weinor product is delivered with a certificate of authenticity. Ask your weinor retailer for it!

Important:
 All the illustrated equipment is weatherproof outdoor furniture and accessories.

Fabric qualities: weinor awning fabrics meet strict quality requirements and are produced using state-of-the-art production technology. Despite this, blemishes like creases, rippling in the seam and hem area, overstretching in the hem area and honeycombing cannot be ruled out. This has no negative impact on the quality and operating life and are not a reason for rejection. For more detailed information: www.weinor.com/fabric_qualities

Awnings and conservatory awnings: must be retracted during rain and windy conditions – otherwise there is a risk of water pooling on the fabric. Fabrics that are allowed to become wet may show creasing, wrinkling or honeycombing as well as having visible water stains. Mould and mildew damage is also a possibility. If taken away wet the awning should be extended as soon as possible once there are dry conditions.

Frame colours: depending on the frame colour ordered, we deliver all small parts, as well as gear handles and gear boxes in black (similar to

RAL 9005), white (similar to RAL 9016), or in grey (similar to weinor 7319).

Patio roofs and Glasoasen®: Ask a qualified weinor retailer about the causes of condensation formation and any cracking sounds which may occasionally be heard (and how to avoid them from the planning stage onwards).

Please note: The weinor Glasoase® is completely watertight and airtight (e.g. with driving rain or draughts).



Front and back cover:
Frame colour WT 029/70786 | **Pattern** 3-716 suede

We reserve the right to make technical changes as well as changes in range and product portfolio. The weinor product range may vary depending on the country. For technical reasons, the colours may appear slightly different when printed.

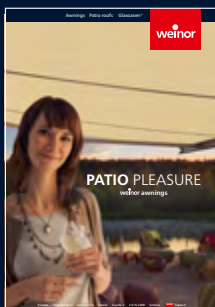

Experience the whole weinor.com world

Your weinor retailer will be pleased to advise you:

Patent no

DE10201115536A1	DE102011120712A1
EP3339559A1	EP3741924A1
EP1835089A3	EP3392446B1
EP1382770A1	DE102010053774B4
DE102006059468A1	EP3246500A1
EP2019346B1	DE102007050522A1
EP3228801B1	DE102015012432A1
EP2383402A2	DE102011109525A1
EP1936105A3	EP3048213B1
EP1564364B1	DE202016007483U1
EP2202376A1	EP3392425B1
EP3450640B1	DE202006003917U1
EP1522650A3	